

A Novel Rectangular Ring Planar Monopole Antennas for Ultra-Wideband Applications

Hemachandra Reddy Gorla* and Frances J. Harackiewicz

Abstract—This paper proposes two rectangular ring planar monopole antennas for wideband and ultra-wideband applications. Simple planar rectangular rings are used to design the planar antennas. These rectangular rings are designed in a way to achieve the wideband operations. The operating frequency band ranges from 1.85 GHz to 4.95 GHz and 3.12 GHz to 14.15 GHz. The gain varies from 1.83 dBi to 2.89 dBi for rectangular ring wideband antenna and 1.89 dBi to 5.2 dBi for rectangular ring ultra-wideband antenna. The design approach and the results are discussed.

1. INTRODUCTION

Ultra-Wideband (UWB) technology provides promising solutions for future communication systems due to excellent immunity to multi-path interference, large bandwidth and high speed data rate. A bandwidth from 3.1 GHz to 10.6 GHz was allocated for UWB systems by the Federal Communication Commission (FCC) since 2002. However, there are more challenges in designing a UWB antenna than a narrow band one. A suitable UWB antenna should be capable of impedance match over an ultra-wide bandwidth.

Different techniques are used by researchers to improve the performance and overall efficiency of UWB antennas. In one such attempt, a planar inverted-F antenna was proposed [1]. The maximum gain of the antenna was 5.7 dBi with an optimized size of 40 mm×60 mm×10 mm and achieved 110% of impedance bandwidth. In another technique a planar monopole antenna [2] for new generation mobile and lower band ultra-wide band applications was designed to operate from 1.5 GHz to 5.5 GHz with 114.3% impedance bandwidth. An Ultra-wideband antenna differential wide-slot antenna with improved radiation patterns and gains is reported in [3]. Its overall size was optimized to 33.6 mm×29.6 mm×0.635 mm and with the gain values from 1.3 dBi to 4.7 dBi. A novel reversed T-match antenna with compact size and low profile for ultra-wideband applications is presented in [4] with maximum gain of 9.14 dBi and the frequency of operation is from 2.89 GHz to 6.5 GHz only. A novel U-slot antenna is presented in [5] with size 67 mm×74 mm×3.175 mm. The novel U-slot antenna is operating from 5.18 GHz to 5.8 GHz with impedance bandwidth of 11.8%. Four U-shaped patch antennas with circular and square ground plane are published in [6] with minimum size 32 mm×32 mm×1.6 mm. The maximum impedance bandwidth achieved was 84.96% from 4.5 GHz to 11.4 GHz and the maximum gain is 4.1 dBi. A compact size UWB antenna is designed in [7] with frequency of operation from 4.2 GHz to 8.5 GHz with a size of 30 mm×34 mm×1.575 mm. A reflector is used to achieve the high gain. A microstrip UWB antenna is presented in [8] with size of 34 mm×36 mm×1.6 mm, operated only from 4.6 GHz to 9.6 GHz. The detailed comparison with other antennas presented in [9–23] is given in Table 1. The proposed rectangular ring ultra-wideband planar monopole antenna has a size of 28 mm×26 mm×1.525 mm with impedance bandwidth of 124.16% and gain varying between 1.89 dBi to 5.2 dBi.

Received 16 November 2015, Accepted 24 December 2015, Scheduled 5 January 2016

* Corresponding author: Hemachandra Reddy Gorla (hrcgorla@siu.edu).

The authors are with the Department of Electrical and Computer Engineering, Southern Illinois University Carbondale, Carbondale, IL 62901, USA.

The simulated and measured results are in good agreement. The proposed wideband rectangular ring monopole antenna has the size of $60\text{ mm} \times 60\text{ mm} \times 1.525\text{ mm}$. The wideband rectangular ring antenna has the impedance bandwidth 88.23% and gain varying from 1.89 dBi to 2.89 dBi. Only designs in [9, 16], and [21] have smaller areas than the proposed antenna, but with larger volumes, lower gains, and smaller bandwidths.

Table 1. Comparison with published antennas.

Published Antennas	Size (mm ³)	Maximum Gain (dBi)	Area (mm ²)	% of Bandwidth
[1]	$40 \times 60 \times 10$	5.7	2400	110
[2]	$57 \times 37.5 \times 0.8$	3.25	2137.5	114.3
[3]	$33.6 \times 29.6 \times 0.635$	4.7	994.56	133.1
[4]	$23 \times 32 \times 18$	9.14	736	76.5
[5]	$67 \times 74 \times 3.125$	7.92	4958	11.8
[6]	$32 \times 32 \times 1.6$	4.25	1024	84.96
[7]	$30 \times 34 \times 12$	9	1020	67.7
[8]	$36 \times 34 \times 1.6$	4.95	1224	70.4
[9]	$15 \times 33 \times 5$	4.15	495	120
[10]	$100 \times 100 \times 0.762$	5	10000	88.8
[11]	$50 \times 50 \times 0.5$	5	2500	70.7
[12]	$32 \times 35 \times 1.5$	5.9	1120	107.2
[13]	$60 \times 30 \times 1.6$	2.2	1800	142
[14]	$32 \times 40 \times 0.76$	3	1280	109.4
[15]	$106 \times 85 \times 0.8$	5	9010	163.6
[16]	$25 \times 28.5 \times 1.27$	--	712.5	80.5
[17]	$46.13 \times 34.9 \times 0.43$	--	1608.8	109.4
[18]	$51.2 \times 62 \times 0.76$	3	3174	85.7
[19]	$57 \times 77 \times 0.76$	6.98	4389	109.4
[20]	$28.5 \times 28 \times 0.8$	2.99	798	110.
[21]	$18 \times 36 \times 11$	3.5	648	110
[22]	$28 \times 29 \times 1.6$	2.35	812	114.3
[23]	$42 \times 42 \times 0.8$	7	1764	119.7
Proposed UWB Antenna	$28 \times 26 \times 1.525$	5.2	728	124.16

2. ANTENNA DESIGN

The antenna was designed by first analyzing a single printed square loop with side lengths equals to one quarter wavelength in the dielectric substrate at the lowest frequency. By parametric analysis and optimization, these dimensions we were changed and up to 4 or 9 connected interior rings were added. As the number of rings increases, impedance matching improves (for $|S_{11}| < -10\text{ dB}$) in the ultra-wide band frequency region. The final radiating element of rectangular UWB monopole antenna consists of five rectangular rings. Figure 1 shows the antenna configuration constructed with the nested rectangular rings. These antennas are fabricated on a Rogers's RT5880LZ substrate with dielectric constant of 1.96 (ϵ_r), loss tangent 0.0019 and thickness of 1.525 mm. The radiating element of the rectangular ring UWB antenna has dimensions $17\text{ mm} \times 11\text{ mm}$. The width of the outer ring and inner rings are $w = 1\text{ mm}$ and $I = 0.5\text{ mm}$ and the gap between the rings is $G = 0.5\text{ mm}$ as shown in Figure 1(a). The rectangular ring

UWB antenna is fed by tapered microstrip line of width $W_{f1} = 5\text{ mm}$ to $W_{f2} = 3.00\text{ mm}$ and length, $L_f = 9.5\text{ mm}$. The size of the partial ground plane is $26\text{ mm} \times 7.75\text{ mm}$ as shown in Figure 1(a). The detailed structure of the radiating element is shown in Figure 1(b). The fabricated rectangular ring UWB antenna is shown in Figure 3(a). The final dimensions of the UWB antenna is given in Table 2.

Unlike some of the other UWB designs, the proposed rectangular ring monopole can be scaled to accommodate the lower frequency bands. The radiating element of wideband rectangular ring monopole antenna has an area of $24\text{ mm} \times 20\text{ mm}$. This antenna is fed with $50\text{-}\Omega$ microstrip line. This antenna consists of ten rectangular rings. The width of the outer ring is 1 mm and all the inner rings have a width of 0.5 mm . The wideband antenna design is shown in Figure 2. The fabricated antenna is shown in Figure 3(b). This antenna has the ground plane of size $60\text{ mm} \times 27.5\text{ mm}$. The detailed dimensions are given in Table 3. The radiating elements of the two antennas are symmetrical along the x -axis and y -axis. The antenna configuration was optimized with CST microwave studios®. The antenna is fabricated using the LPKS-s62 milling machine. The resolution of the machine is 0.01 mm .

Between two rings there are either three, two, or one connection points per side. If the inner length of the outer ring is L , then the center of the connection points are at a combination of three points. Point 'a' is at $L/4$. Point 'b' is at $L/2$. Point 'c' is at $3L/4$. In the case of three connections 'a', 'b' and 'c' are used. In the case of two connections, only 'a' and 'c' are used. In the case of one connection, only point 'b' is used. The number of connections from outer most to inner most on the five-ring four-gap design is 3, 2, 1, and 1 respectively. For the ten-ring, nine-gap design, the number of connections in order from outermost to innermost gap is 3, 2, 1, 3, 2, 1, 3, 2, and 1. The possible connection configurations is shown in Figure 4.

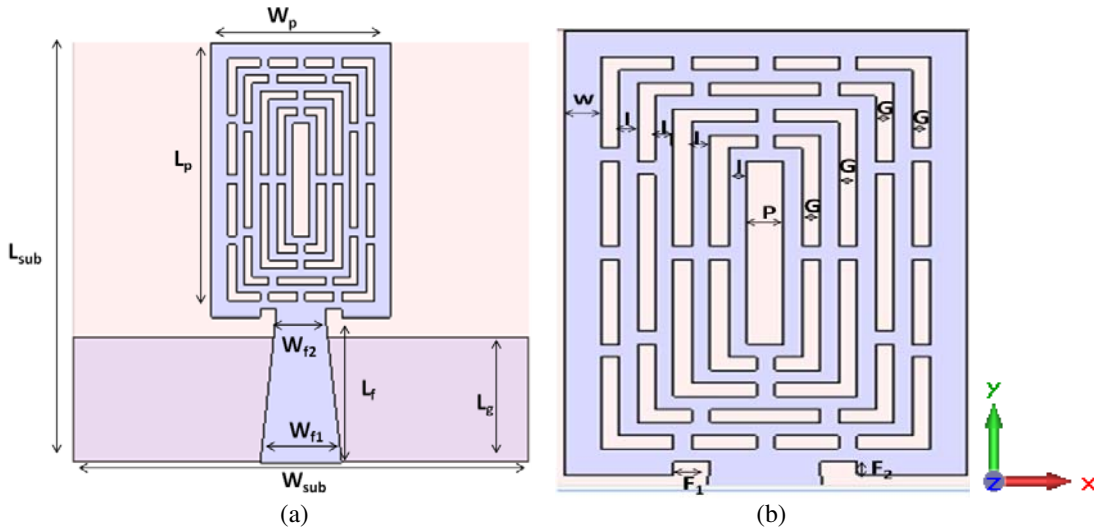

Figure 1. Rectangular ring UWB antenna.

Table 2. Final dimensions of rectangular ring UWB antenna.

Parameter	L_{sub}	W_{sub}	L_p	W_p	W_{f1}	W_{f2}	L_f	L_g	I	w	G	F_1	F_2
Value (mm)	26	24	17	11	5	3	9.5	7.75	0.5	1	0.5	1	0.5

Table 3. Final dimensions of rectangular wideband antenna.

Parameter	L_{sub}	W_{sub}	L_p	W_p	W_{f1}	L_f	L_g	I	w	G	F_1	F_2
Value (mm)	60	60	20	24	3	30	27.75	0.5	1	0.5	1	0.5

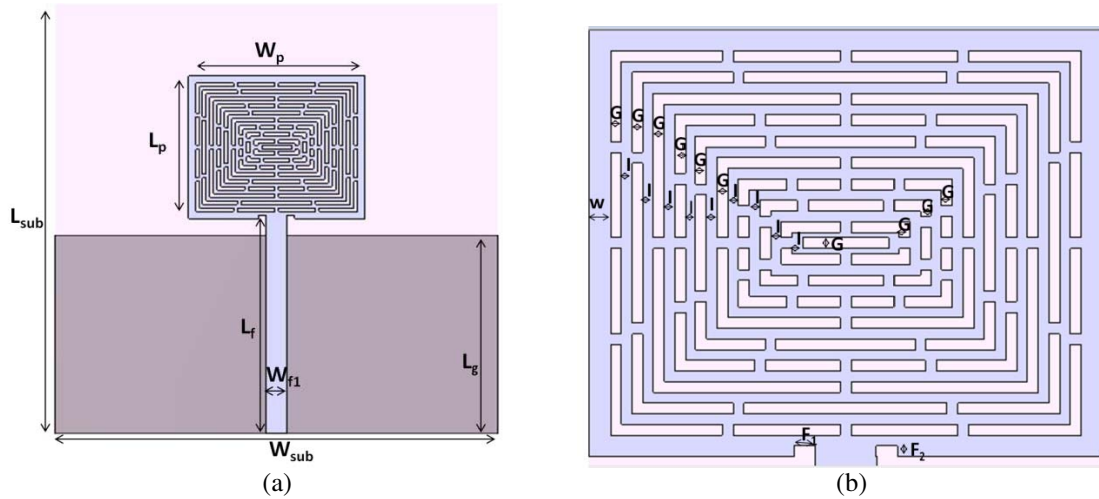

Figure 2. Rectangular ring wideband antenna.

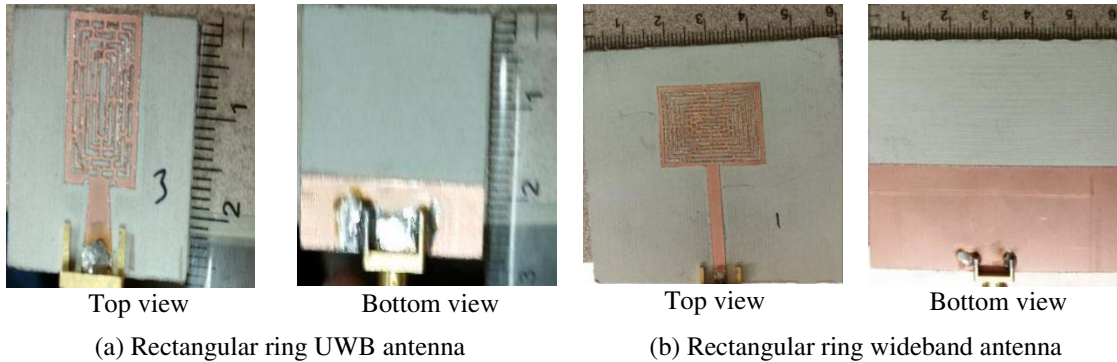

Figure 3. Fabricated antennas.

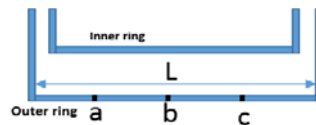

Figure 4. Possible connection points between two rings.

3. SIMULATED AND MEASURED RESULTS

The effect of the parameters on impedance bandwidth is discussed in this section. The initial length of the rectangular ring UWB antenna ring (L_p) was calculated by quarter wavelength ($\lambda/4$) at 3.1 GHz which is equal to 17.2 mm. Where λ is the wavelength in the dielectric substrate. The simulated impedance bandwidths ($|S_{11}| < -10$ dB) of the UWB antenna and wideband antennas with different number of rings are as shown in Figure 5 and Figure 6 respectively.

The impedance bandwidths of rectangular ring UWB antenna and wideband antenna with the different ground plane sizes are shown in Figure 7 and Figure 8. To achieve good impedance matching within the frequency band of operation, parametrical analysis is carried out with different ground plane sizes. The simulated results of the same size planar monopole antenna with the same size (17 mm \times 11 mm) radiating element gives a much smaller bandwidth from 3.2 GHz to 6.1 GHz, whereas for the larger-sized wideband antenna radiating element (24 mm \times 20 mm) gives impedance bandwidth from 2.89 GHz to 4.5 GHz.

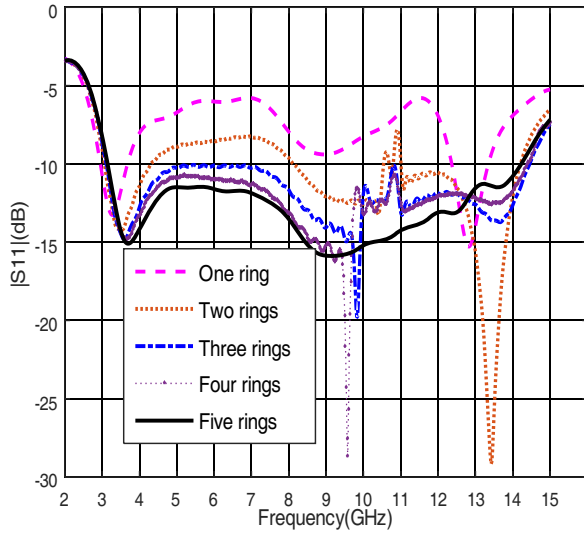

Figure 5. Effect of number of rings on $|S_{11}|$ (dB) for the rectangular-ring UWB antenna.

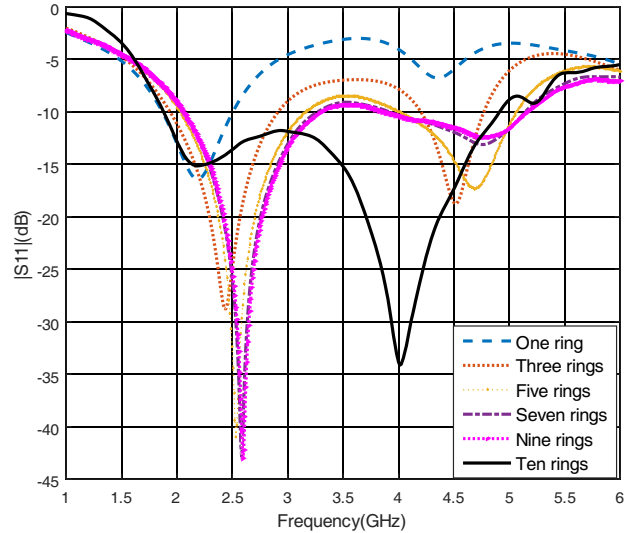

Figure 6. Effect of number of rings on $|S_{11}|$ (dB) of rectangular ring wideband antenna.

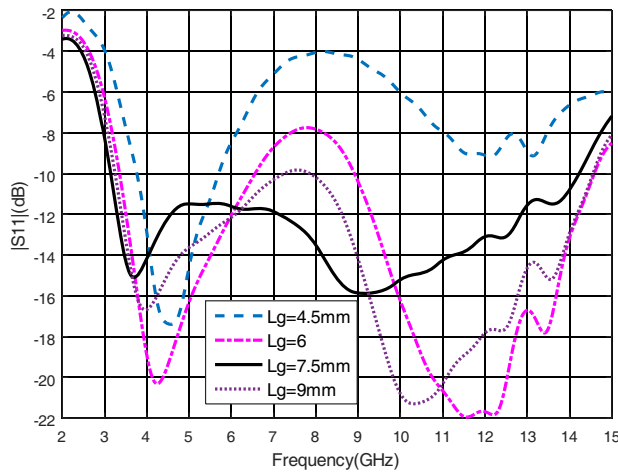

Figure 7. Impedance bandwidth with different ground plane lengths on UWB antenna.

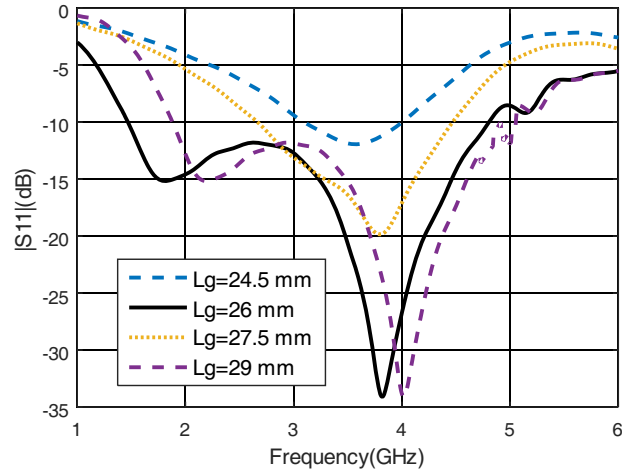

Figure 8. $|S_{11}|$ vs. frequency with different ground plane lengths on wideband antenna.

Measured and simulated results of impedance bandwidth is shown in the Figures 9 and 10. The simulated impedance bandwidth of the rectangular ring UWB antenna is 124.16% from 3.1 GHz to 14.15 GHz, whereas for the scaled version antenna is 93.3% from 1.8 GHz to 4.95 GHz. The measured impedance bandwidth of the rectangular ring UWB antenna is from 3.12 GHz to 12.85 GHz. The variation in the simulated and measured impedance bandwidth is due to imperfections in the fabrication.

The surface current distributions at different frequencies of these antennas are shown in the Figure 11. At the 3 GHz, the surface current is more concentrated along the feed line, outer edges and as well as over the inner ring edges. At 6 GHz and 9 GHz, the surface current is concentrated on the radiating element outer edges. These currents are causing a resonance at higher frequency. The measured peak gain of the antennas is shown in Figure 12. The measured peak gain of the rectangular ring UWB is 5.2 dBi at 10.5 GHz. The gain comparison method is used to calculate the gain of the proposed antennas. The rectangular ring wideband antenna has its peak gain of 2.89 dBi at 4.5 GHz. Measured and simulated radiation patterns of the proposed antennas are shown Figures 13 and 14. The radiation patterns are approximate monopole radiation patterns. The radiation pattern deformed due

to the small ground plane size for the high frequency. At higher frequencies, the UWB radiation became more directive causing peak gain appears at 10.5 GHz. The RF cable is effected the performance of the antenna which causes the ripples in the measured patterns. The NSI near field spherical anechoic chamber is used to measure the radiation pattern.

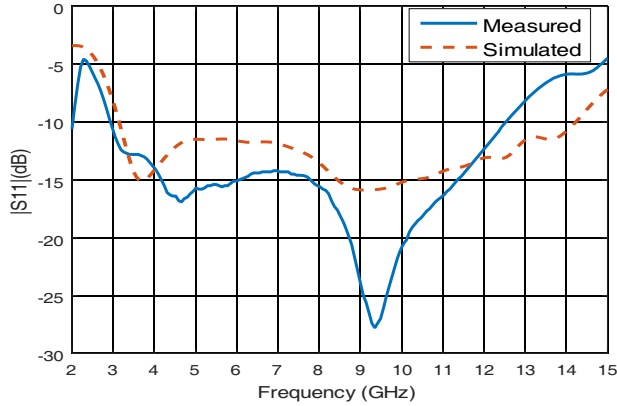

Figure 9. Simulated and measured impedance bandwidth of rectangular ring UWB antenna.

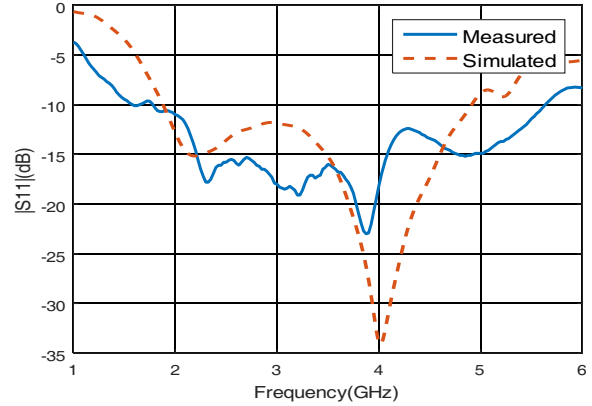

Figure 10. Simulated and measured impedance bandwidth of rectangular ring wideband antenna.

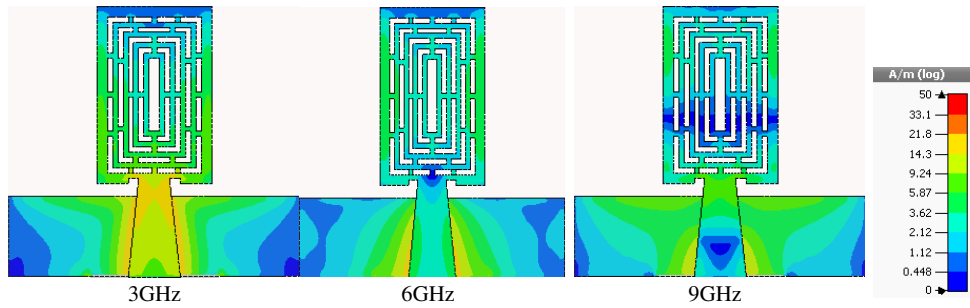
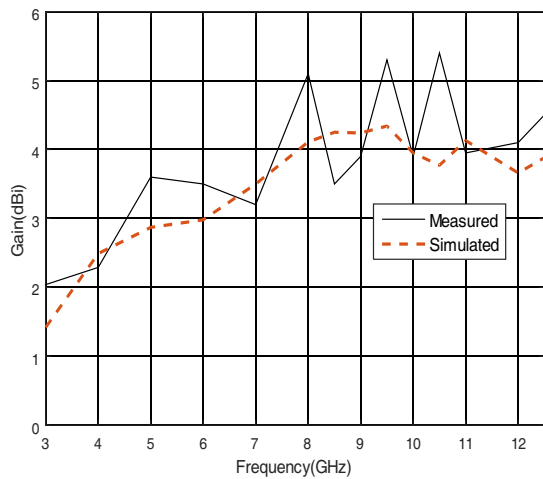
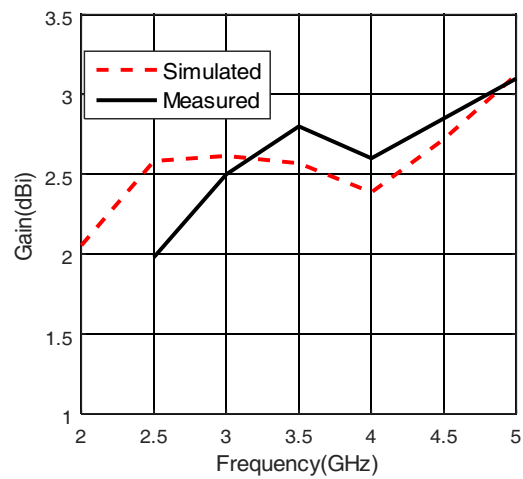

Figure 11. Rectangular ring UWB antenna surface current distributions at various frequencies.



(a) Rectangular ring UWB planar monopole antenna



(b) Rectangular ring planar monopole wide band antenna

Figure 12. Measured and simulated gain of both the antennas.

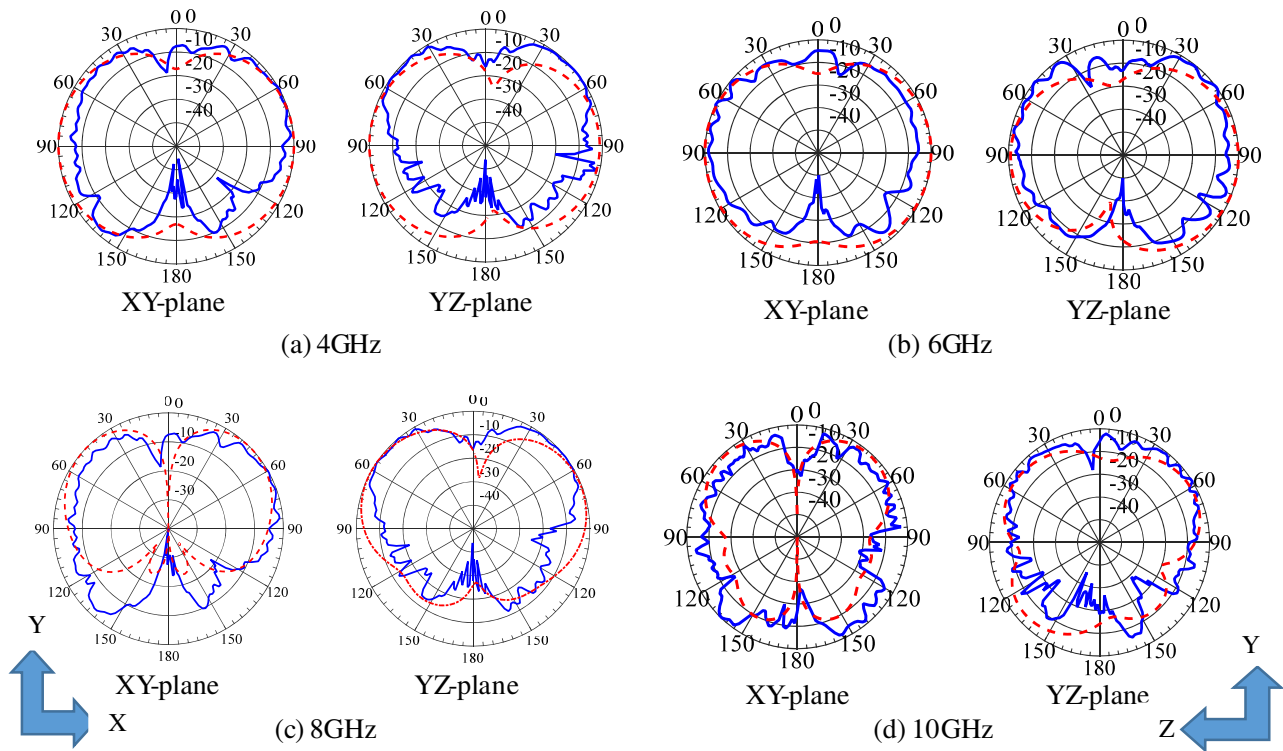

Figure 13. Simulated (Red line dashed) and measured (Blue line solid) radiation pattern of rectangular ring UWB antenna.

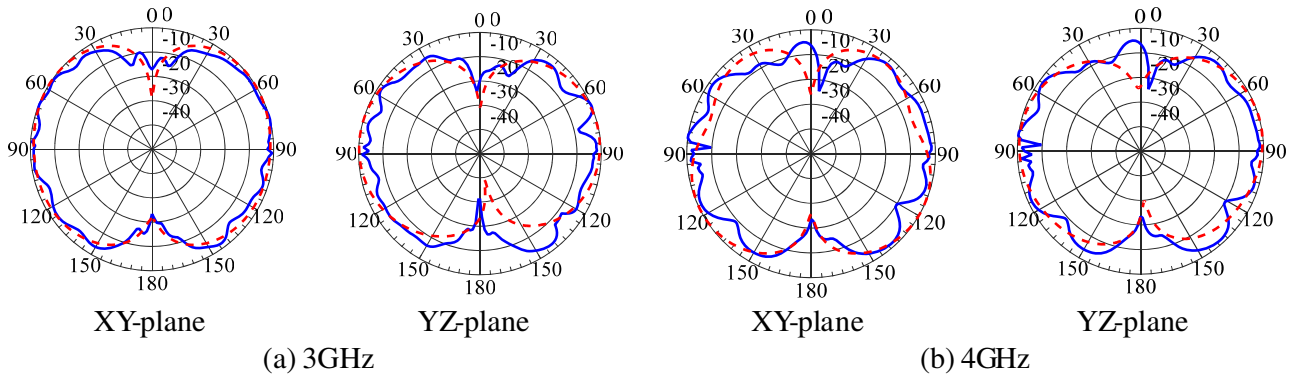

Figure 14. Simulated (Red line dashed) and measured (Blue line solid) radiation pattern of rectangular wideband antenna.

4. CONCLUSIONS

The rectangular ring UWB antenna was designed to operate from 3.10 GHz to 14.15 GHz. The overall size of the antenna was optimized to 26 mm×28 mm×1.525 mm. This antenna has a maximum gain of 5.2 dBi. The wideband antenna operates from 1.8 GHz to 4.98 GHz. The frequency of operation could be lowered by increasing the number of rings with optimum sizes. The fractional bandwidths varied between 1.28 and 0.93, and the design was found to be scalable. Even with the scaling of the antenna, the fractional bandwidth will be approximately same. The proposed method of antenna design is easy to fabricate and integrate and can be used to design wideband and ultra-wideband antennas. Similar techniques were shown to be successful for the circular rings and hexagonal rings.

REFERENCES

1. Chattha, H. T., Y. Huang, M. K. Ishfaq, and S. J. Boyes, "Bandwidth enhancement techniques for planar inverted-F antenna," *IET Microwaves, Antennas & Propagation*, Vol. 5, No. 15, 1872–1879, December 9, 2011.
2. See, C. H., R. A. Abd-Alhameed, F. Elmegri, D. Zhou, J. M. Noras, N. J. McEwan, S. M. R. Jones, and P. S. Excell, "Planar monopole antennas for new generation mobile and lower band ultra-wide band applications," *IET Microwaves, Antennas & Propagation*, Vol. 6, No. 11, 1207–1214, August 21, 2012.
3. Weng, Y. F., S. W. Cheung, and T. I. Yuk, "Design of multiple band-notch using meander lines for compact ultra-wide band antennas," *IET Microwaves, Antennas & Propagation*, Vol. 6, No. 8, 908–914, June 7, 2012.
4. Li, L., J. Yang, X. Chen, X. Zhang, R. Ma, and W. Zhang, "Ultra-wideband differential wide-slot antenna with improved radiation patterns and gain," *IEEE Transactions on Antennas and Propagation*, Vol. 60, No. 12, 6013–6018, December 2012.
5. Wang, S., Q. Wu, and D. Su, "A novel reversed t-match antenna with compact size and low profile for ultrawideband applications," *IEEE Transactions on Antennas and Propagation*, Vol. 60, No. 10, 4933–4937, October 2012.
6. Khidre, A., K.-F. Lee, A. Z. Elsherbeni, and F. Yang, "Wide band dual-beam U-slot microstrip antenna," *IEEE Transactions on Antennas and Propagation*, Vol. 61, No. 3, 1415–1418, March 2013.
7. Mandal, K. and P. P. Sarkar, "High gain wide-band U-shaped patch antennas with modified ground planes," *IEEE Transactions on Antennas and Propagation*, Vol. 61, No. 4, 2279–2282, April 2013.
8. Zhu, F., S. Gao, A. T. S. Ho, T. W. C. Brown, J. Li, and J.-D. Xu, "Low-profile directional ultra-wideband antenna for see-through-wall imaging applications," *Progress In Electromagnetics Research*, Vol. 121, 121–139, 2011.
9. Lim, K.-S., M. Nagalingam, and C.-P. Tan, "Design and construction of microstrip UWB antenna with time domain analysis," *Progress In Electromagnetics Research M*, Vol. 3, 153–164, 2008.
10. Kishk, A. A., X. H. Wu, and K. S. Ryu, "UWB antenna for wireless communication and detection applications," *2012 IEEE International Conference on Ultra-Wideband (ICUWB)*, 72–76, September 17–20, 2012.
11. Fujita, S., M. Yamamoto, and T. Nojima, "A study of a leaf-shaped bowtie slot antenna for UWB applications," *2012 International Symposium on Antennas and Propagation (ISAP)*, 830–833, October 29–November 2, 2012.
12. Dissanayake, T. and K. P. Esselle, "UWB performance of compact L-shaped wide slot antennas," *IEEE Transactions on Antennas and Propagation*, Vol. 56, No. 4, 1183–1187, April 2008.
13. Lu, Y., Y. Huang, H. T. Chattha, and P. Cao, "Reducing ground-plane effects on UWB monopole antennas," *IEEE Antennas and Wireless Propagation Letters*, Vol. 10, 147–150, 2011.
14. Tsai, C.-L. and C.-L. Yang, "Novel compact eye-shaped UWB antennas," *IEEE Antennas and Wireless Propagation Letters*, Vol. 11, 184–187, 2012.
15. Fereidoony, F., S. Chamaani, and S. A. Mirtaheri, "Systematic design of UWB monopole antennas with stable omnidirectional radiation pattern," *IEEE Antennas and Wireless Propagation Letters*, Vol. 11, 752–755, 2012.
16. Nazli, H., E. Bicak, B. Turetken, and M. Sezgin, "An improved design of planar elliptical dipole antenna for UWB applications," *IEEE Antennas and Wireless Propagation Letters*, Vol. 9, 264–267, 2010.
17. Verbiest, J. R. and G. A. E. Vandebosch, "A novel small-size printed tapered monopole antenna for UWB WBAN," *IEEE Antennas and Wireless Propagation Letters*, Vol. 5, No. 1, 377–379, December 2006.
18. Dullaert, W. and H. Rogier, "Novel compact model for the radiation pattern of UWB antennas using vector spherical and slepian decomposition," *IEEE Transactions on Antennas and Propagation*, Vol. 58, No. 2, 287–299, February 2010.

19. Lizzi, L., R. Azaro, G. Oliveri, and A. Massa, "Printed UWB antenna operating over multiple mobile wireless standards," *IEEE Antennas and Wireless Propagation Letters*, Vol. 10, 1429–1432, 2011.
20. Fereidoony, F., S. Chamaani, and S. A. Mirtaheeri, "UWB monopole antenna with stable radiation pattern and low transient distortion," *IEEE Antennas and Wireless Propagation Letters*, Vol. 10, 302–305, 2011.
21. Wong, S. W., T. G. Huang, C. X. Mao, Z. N. Chen, and Q. X. Chu, "Planar filtering ultra-wideband (UWB) antenna with shorting pins," *IEEE Transactions on Antennas and Propagation*, Vol. 61, No. 2, 948–953, February 2013.
22. Abedian, M., S. K. A. Rahim, and M. Khalily, "Two-segments compact dielectric resonator antenna for UWB application," *IEEE Antennas and Wireless Propagation Letters*, Vol. 11, 1533–1536, 2012.
23. Rahim, S. A., S. Danesh, U. A. Okonkwo, M. Sabran, and M. Khalily, "UWB monopole antenna with circular polarization," *Microw. Opt. Technol. Lett.*, Vol. 54, 949–953, 2012.