

## DUAL AND TRI-BAND-NOTCHED ULTRAWIDEBAND (UWB) ANTENNAS USING COMPACT COMPOSITE RESONATORS

Xing Qun Qi\*, Hong-Chun Yang, Di Kai Liu, and Yang Li

School of Physical Electronics, University of Electronic Science and Technology of China, Chengdu 610054, China

**Abstract**—An ultra-wideband (UWB) antenna with triple band-notched characteristics is presented in this paper. The triple-notched bands (5.15–5.35 GHz and 5.725–5.825 GHz for WLAN, 7.9–8.395 GHz for X-band) are achieved by using only one novel composite resonator with multiple resonant characteristics. The resonator is placed on the back surface of the substrate and connected to the radiation patch through one via-hole. An equivalent circuit model is built for analyzing the band-notched characteristics. Moreover, the notched bands can be adjusted independently, and the resonator structure is very compact.

### 1. INTRODUCTION

In recent years, many kinds of narrowband resonators have been embedded in UWB antennas for the notched bands, because there are several other existing narrowband services which occupy frequency bands within the designated UWB bandwidth, and the problem of electromagnetic interference has drawn heavy attention from researchers.

The most popular resonator designs for notched band within UWB are embedding slots on the patch or ground plane [1–3]. Usually, in this way the structure is simple, but loss is great. So it is difficult to achieve narrow notched band. Another way is adding parasitic elements by two approaches. One is adding parasitic elements close to the feed line [4–6]. One parasitic element can introduce one notched band, even narrow notched band [4, 6], with the advantage of tuning independently, which makes the design easier. However, more resonators are needed for more notched bands. As a result, the antenna is not very compact, or the

---

*Received 23 July 2013, Accepted 7 September 2013, Scheduled 8 September 2013*

\* Corresponding author: Xing Qun Qi (qxqdongbei@163.com).

space is not enough. The other approach is adding parasitic elements on the back of the patch. For instance, in [7] an open loop resonator is located on the back of the substrate for single notched band design. In order to generate more notched bands, a pair of nested C-shaped stubs [8] or three crescent-shaped resonators [9] are inserted on the back surface of the substrate and short-circuited to the radiation patch using via holes. Further, using more compact resonators for band-notched antenna is also worth studying.

In this paper, the dual band-notched UWB antenna for the closely adjacent frequencies associated with the lower and higher WLAN bands (5.15–5.35 and 5.725–5.825 GHz) is designed. Only one composite resonator composed of folded E-shaped stub and T-shaped stub is connected to the patch from the back for two notched bands. Furthermore, a novel composite resonator composed of one folded E-shaped stub and three T-shaped stubs is designed for triple band-notched UWB antenna. Consequently, the rejected band can be tuned independently, and the structure is very compact. Good agreements are observed between the measured and simulated results, which demonstrate that the method is effective.

## 2. ANTENNA DESIGN AND ANALYSIS

In order to illustrate the effectiveness of the method, in this paper, a circular monopole antenna is used for band-notched antenna design as shown in Fig. 1. The structure is printed on a 0.813-mm-thick RO4003C substrate with the relative permittivity of  $\epsilon_r = 3.38$ . The simulations are carried out by CST Microwave Studio in this study.

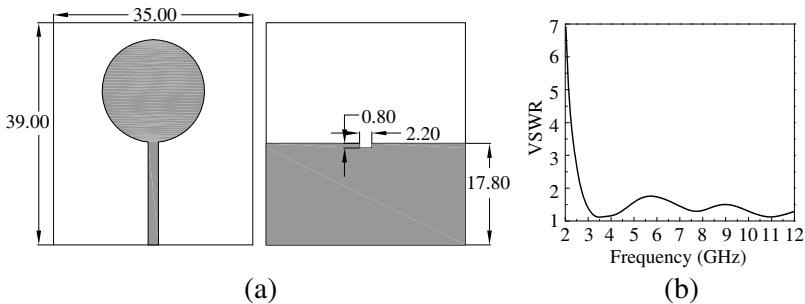

**Figure 1.** UWB circle monopole antenna. (a) Top view and bottom view (unit: mm). (b) Simulated VSWR.

### 2.1. Band-notched Characteristic Analysis

Figure 2 shows the geometry of a single band-notched UWB antenna (the back structure is shaded gray, while the positive structure is not filled with color). The red circle is via-hole.

As shown in Fig. 2, a folded E type stub is connected to radiator directly through via-hole (the radius is  $R_0$ ), and it can be considered as two  $\lambda_g/4$  type resonators ( $\lambda_g$  is the guided wavelength at the rejected band) shunt-connected to the antenna. The physical length can be designed as follow:

$$L_{11} + L_{12} + L_{13} + L_t \approx \lambda_g/4 \tag{1}$$

At the notch frequency, the surface currents concentrated around the resonator have opposite directions between the resonator and radiation patch so that the resultant radiation fields cancel out. Finally, a single band-notched antenna can be achieved.

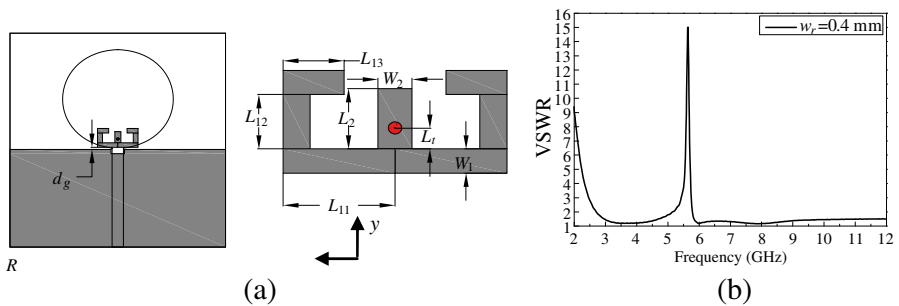

**Figure 2.** Single band-notched UWB antenna with the folded E-shaped resonator. (a) Bottom view and enlarged view of the folded E-shaped resonator. (b) Simulated VSWR value for single band-notched UWB antenna with the folded E-shaped resonator. ( $d_g = 0.4 \text{ mm}$ ,  $R_0 = 0.2 \text{ mm}$ ,  $L_{11} = 3.3 \text{ mm}$ ,  $L_{12} = 1.8 \text{ mm}$ ,  $L_{13} = 1.8 \text{ mm}$ ,  $L_2 = 2 \text{ mm}$ ,  $L_t = 1.5 \text{ mm}$ ,  $W_1 = 0.8 \text{ mm}$ ,  $W_2 = 1.0 \text{ mm}$ ).

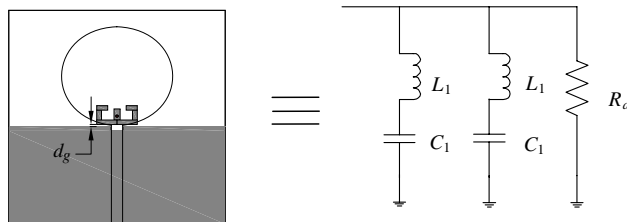
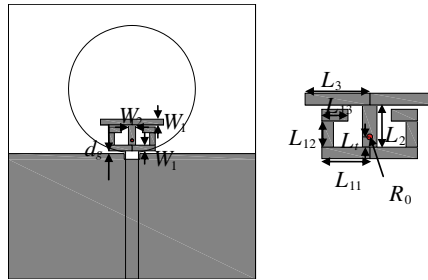

**Figure 3.** Geometry and equivalent circuit of the proposed single band-notched UWB antenna.

To explain the principle of band-notched characteristics, the conceptual equivalent circuit mode can be built as in Fig. 3. The shunt-connected  $\lambda_g/4$  open-circuited stubs can be modeled as shunt-connected series LC resonance circuits, and the antenna resistance is  $R_a$ , so that the antenna has band-stop filter characteristics. Based on above analysis, more notched bands may be achieved at desired frequencies by adding more  $\lambda_g/4$  open-circuited stubs.

## 2.2. Dual Band-notched UWB Antenna

As shown in Fig. 4, putting the folded E-shaped resonator and T-shaped resonator together makes a new resonator with dual resonant characteristics. The first rejected band  $f_{\text{notch1}}$  (5.15–5.35 GHz) corresponding to the T-shaped resonator and the second rejected band  $f_{\text{notch2}}$  (5.725–5.825) corresponding to the folded E-shaped resonator are designed. Based on the equivalent circuit model of the single band-notched UWB antenna, the T-shaped stub is equivalent to two shunt-



**Figure 4.** Geometry of the proposed dual band-notched UWB antenna.

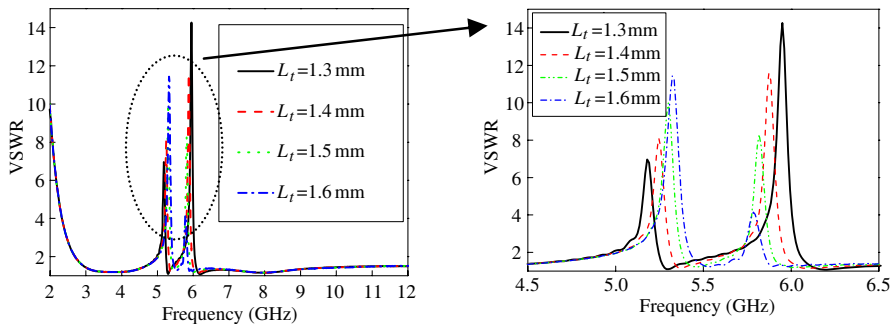

**Figure 5.** Influence of the position of via-hole  $L_t$  on VSWR of the UWB antenna.

connected series LC resonance circuits. The notched frequency can be calculated as follow:

$$f_{\text{notch1}} = \frac{c}{4(L_3 + L_2 - L_t)\sqrt{\epsilon_{\text{eff}}}} \tag{2}$$

$$f_{\text{notch2}} = \frac{c}{4(L_{11} + L_{12} + L_{13} + L_t)\sqrt{\epsilon_{\text{eff}}}} \tag{3}$$

where  $\epsilon_{\text{eff}}$  is the effective dielectric constant and  $c$  the speed of light. According to (2) and (3), the distance of two notched bands can be adjusted by the parameter  $L_t$  as shown in Fig. 5.

### 2.3. Triple Band-notched UWB Antenna

Besides the lower and upper WLAN bands, X-band communication satellites system band (7.9–8.395 GHz) also operates within the UWB band. In order to reduce the potential electromagnetic interference effects, a tri-band notched design is obtained. In the same way as the single and dual band-notched UWB antenna, adding two T-shaped stubs at the middle of a folded E-shaped resonator and T-shaped resonator as shown in Fig. 6, a tri-band notched antenna is achieved. The X-band is corresponding to the folded E-shaped resonator. The lower and upper of WLANs are corresponding to the T-shaped resonator and the newly added T-shaped stubs, respectively. The newly added T-shaped stubs are  $\lambda_g/4$  type stepped impedance resonators. The resonant frequency can be adjusted by changing length and impedance ratio of these T-shaped stubs.

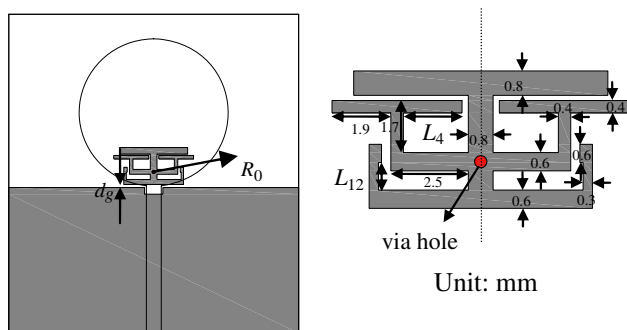

**Figure 6.** Geometry of triple band-notched antenna (refer to Fig. 5 the E-shaped and T-shaped resonators relevant parameters have become to  $d_g = 0.4$  mm,  $L_{11} = 3.6$  mm,  $L_{12} = 0.9$  mm,  $L_{13} = 0.4$  mm,  $L_2 = 3.1$  mm,  $L_3 = 4.1$  mm,  $L_t = 1.5$  mm,  $R_0 = 0.2$  mm for the tri-band notched UWB antenna, and  $L_4 = 1.9$  mm).

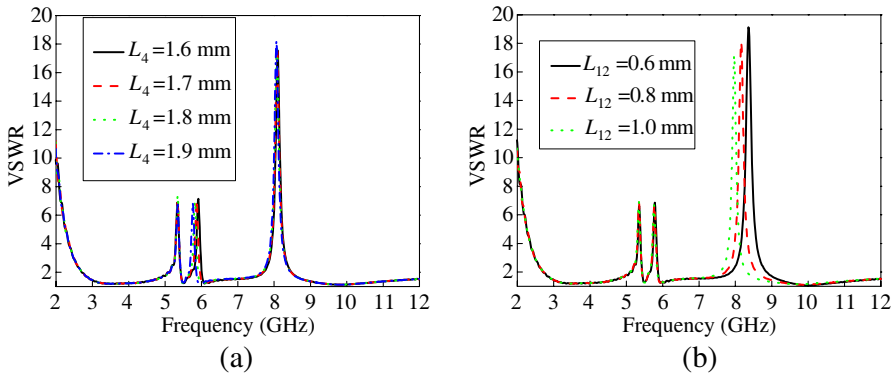

**Figure 7.** Simulated VSWR values versus frequency by varying the size of stubs.

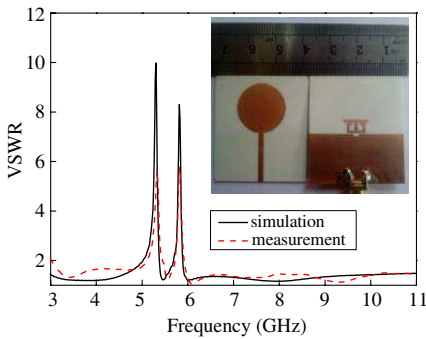

**Figure 8.** Simulated and measured VSWR of the antenna with dual notched bands.

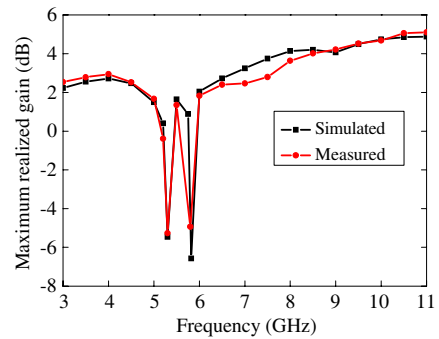

**Figure 9.** Simulated and measured maximum realized gain.

As the coupling strength between the stubs is weak, the second and third notched bands can be tuned independently as shown in Fig. 7, which makes the design more flexible.

### 3. EXPERIMENTAL RESULT AND DISCUSSION

#### 3.1. Results of Dual Band-notched UWB Antenna

A prototype of the proposed composite resonator for dual band-notched UWB antenna with optimal design, i.e.,  $d_g = 0.4$  mm,  $L_{11} = 3.3$  mm,  $L_{12} = 1.8$  mm,  $L_{13} = 1.8$  mm,  $L_2 = 2.9$  mm,  $L_3 = 4.45$  mm,  $L_t = 1.5$  mm,  $W_1 = 0.8$  mm,  $W_2 = 1.0$  mm,  $R_0 = 0.2$  mm, is shown in Fig. 4.

The measured and simulated VSWR values and maximum realized gain versus frequency for the dual band-notched UWB antenna with this composite resonator are compared in Fig. 8 and Fig. 9. The results are in good agreement. The measured dual band-notched frequencies cover 5.10–5.44 GHz and 5.72–5.92 GHz. As shown in Fig. 9, the antenna gain significantly decreases over these dual band-notched frequency sets.

### 3.2. Results of Triple Band-notched UWB Antenna

The simulated and measured VSWR results can be observed in Fig. 10 with the parameter values shown in Fig. 6. The measured three notched-bands cover 5.08–5.45 GHz, 5.62–5.93 GHz, and 7.81–

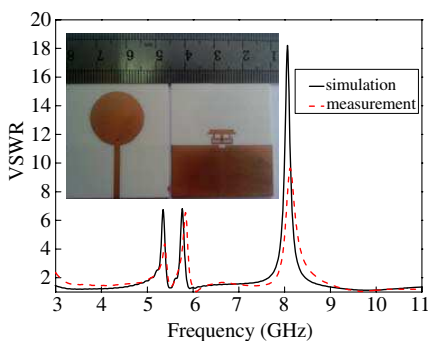

**Figure 10.** Comparison of the measured and simulated VSWR values of the tri-band notched UWB antenna.

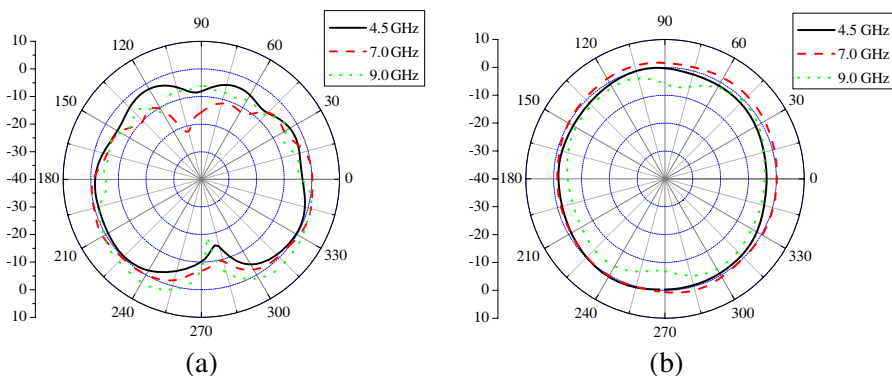

**Figure 11.** Measured radiation patterns at 4.5 GHz, 7.0 GHz and 9.0 GHz. (a) *E*-plane. (b) *H*-plane.

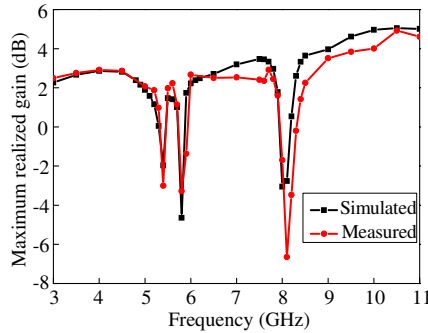

**Figure 12.** Comparison of the measured and simulated maximum realized gain values for the tri-band notched UWB antenna.

8.73 GHz. Fig. 11 shows that the radiation patterns of the proposed triple band-notched UWB antenna at 4.5 GHz, 7 GHz, and 9 GHz. It can be seen that the antenna gain significantly decreases at these three band-notched frequencies in Fig. 12.

#### 4. CONCLUSION

In this paper, a new resonator for a dual band-notched UWB antenna (5.10–5.44 GHz and 5.72–5.92 GHz) is designed. Furthermore, adding two T-shaped stubs, tri-band notched (5.08–5.45 GHz, 5.62–5.93 GHz and 7.81–8.73 GHz) UWB antenna is achieved. The second and third rejected bands can be independently adjusted. The dual and triple band-notched UWB antennas are fabricated and measured. Good agreement is observed between the measured and simulated results. Hence, it is a new way for multi-notched band with one resonator for UWB system. The proposed antennas are expected to be good candidates in UWB systems.

#### REFERENCES

1. Chu, Q.-X. and Y.-Y. Yang, “A compact ultrawideband antenna with 3.4/5.5 GHz dual band-notched characteristics,” *IEEE Trans. Antennas Propag.*, Vol. 56, No. 12, 3637–3644, Dec. 2008.
2. Trang, N. D., D. H. Lee, and H. C. Park, “Very compact printed triple band-notched UWB antenna with quarter-wavelength slots,” *IEEE Antennas Wireless Propag. Lett.*, Vol. 11, 411–414, 2012.



3. Trang, N. D., D. H. Lee, and H. C. Park, "Design and analysis of compact printed triple band-notched UWB antenna," *IEEE Antennas Wireless Propag. Lett.*, Vol. 10, 403–406, 2011.
4. Peng, L. and C.-L. Ruan, "UWB band-notched monopole antenna design using electromagnetic-bandgap structures," *IEEE Trans. Antennas Propag.*, Vol. 59, No. 4, 1074–1081, Apr. 2011.
5. Lin, C.-C., P. Lin, and R. W. Ziolkowski, "Single, dual and tri-band ultrawideband (UWB) antennas using capacitively loaded loop (CLL) resonators," *IEEE Trans. Antennas Propag.*, Vol. 60, No. 1, 102–109, Jan. 2012.
6. Li, T., H. Q. Zhai, G. H. Li, L. Li, and C. H. Liang, "Compact UWB band-notched antenna design using interdigital capacitance loading loop resonator," *IEEE Antennas Wireless Propag. Lett.*, Vol. 11, 724–727, 2012.
7. Kelly, J. R., P. S. Hall, and P. Gardner, "Band-notched UWB antenna incorporating a microstrip open-loop resonator," *IEEE Trans. Antennas Propag.*, Vol. 59, No. 8, 3045–3048, Aug. 2011.
8. Emadian, S. R., C. Ghobadi, J. Nourinia, M. H. Mirmozafari, and J. Pourahmadazar, "Bandwidth enhancement of CPW-fed circle-like slot antenna with dual band-notched characteristic," *IEEE Antennas Wireless Propag. Lett.*, Vol. 11, 543–546, 2012.
9. Li, L., Z.-L. Zhou, and J.-S. Hong, "Compact UWB antenna with four band-notches for UWB applications," *Electron. Lett.*, Vol. 47, No. 22, 1211–1212, Oct. 2011.