

Broadband Switchable 3D Structure Used for Protecting Information Equipment from Electromagnetic with Strong Field

Bo Yi*, Xiwei Geng, and Li Yang

Abstract—This paper presents a broadband switchable 3D structure, which can be used to protect the information equipment from high intensity microwave wave. Compared to other designs, the proposed structure in this paper has wider working band. When the amplitude of incident wave within working band is low, the structure will allow them to pass with little loss. As the amplitude of incident wave is high enough to activate diode, the wave will be reflected. The full-wave simulations are performed in CST to analyze the transmission performance. The simulated results verify the transmission performance and defending function. Its working principle is explained through change of the effective material parameters at two states. A prototype is fabricated. The protection property of the structure as a function of intensity of incident wave is verified in waveguide simulator.

1. INTRODUCTION

As the high intensity sources, such as microwave oven, have easy access to public, the safety of information equipment faces great challenges [1]. In recent years, nonlinear structures, which load diodes or varactors, appear and present power-dependent properties. Monni et al. designed a limiting frequency selective surface, which shifted the passband to higher frequency as the amplitude of incident wave exceeded threshold [2]. Yang et al. proposed energy selective surface, which allowed signal with low amplitude to pass without loss and shield the high intensity one [3]. Katko et al. using PIN diodes designed RF limiter metamaterial [4]. In 2016, Kim et al. presented a nonlinear metasurface based on the nonlinear circuits [5–9]. The metasurface transmits low power signals but absorbs high intensity ones. Similar works were done by Wakatsuchi et al. [8, 9]. Wall et al. proposed a broadband switching nonlinear metamaterial, which reflected the low power signals and propagated the high power ones [10]. However in reality, we often hope the signal with low amplitude to pass with little loss. Scott et al. adopted phase change material loaded FSS to realize adaptive protection. The resistivity of phase change material decreases abruptly when reaching a given temperature [11].

Here, another 3D nonlinear structure is presented. At normal states, the wave can propagate through the structure. When the amplitude of incident wave is high enough to activate the diodes, the wave will be reflected. Compared to other designs, the proposed structure in this paper has wider working band.

The paper is organized as follows. The designed 3D structure is presented in Section 2. The dimensions of the 3D structure and the simulated transmission and characteristics with different numbers of cells in transmission direction are also given in this section. In Section 3, the measured results in waveguide are provided. The conclusions are drawn in Section 4.

Received 30 October 2017, Accepted 23 November 2017, Scheduled 6 December 2017

* Corresponding author: Bo Yi (ybtlyb@163.com).

The authors are with the PLA NO. 78118 Troop, Chengdu, Si Chuan, China.

2. DESIGN AND SIMULATION

The unit cell of the structure, shown in Fig. 1, consists of two separate components. PIN diode is employed in order to alter the effective material parameters of the structure when intensity of incident wave exceeds designed threshold. The meandering shape traces present an exclusively electric response. The equivalent inductance of the traces is very large. The other electric element is diode loaded dipole. When the diode is on, it is regarded as a metal, and the equivalent circuit of element can be represented by an inductor. When the diode is off, the equivalent circuit of element can be replaced by a capacitor. Fig. 1(b) shows four cells of the structure connected to each other in series in the propagation of wave.

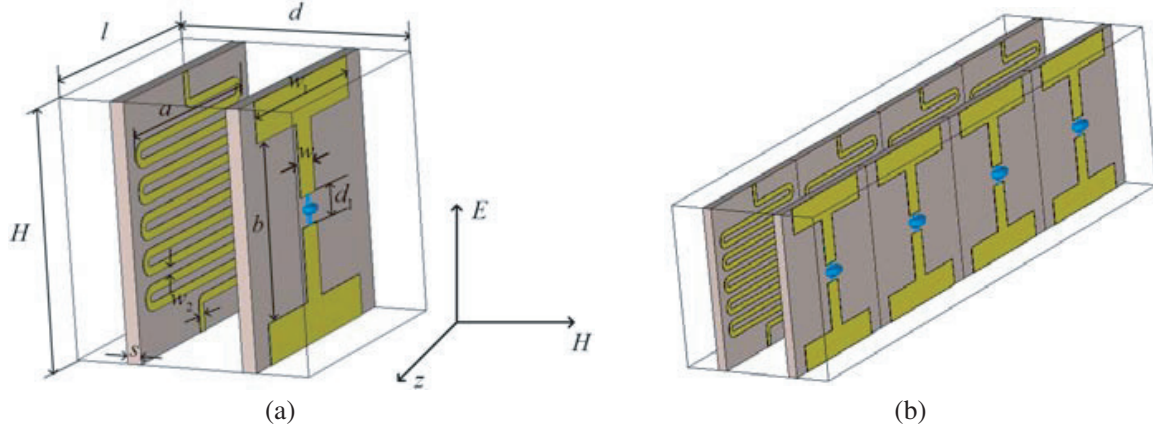

Figure 1. Unit cell of 3D structure. (a) Basic unit cell of designed structure. (b) Connecting four basic unit cell together.

When being excited with different intensities of electromagnetic waves, whose direction of electric field E is shown in Fig. 1(a), the structure has two working states. When the intensity of incident wave is below activation voltage of diode, the permittivity and permeability of the structure are both positive, and most of the energy in passband will penetrate the structure with low loss. At this case, the structure acts as a bandpass filter. While the amplitude of incident wave is large enough to activate diode, the separated dipoles are equivalent to being connected to each other, and the electromagnetic wave is reflected.

Simulations of this structure are performed in CST MWS. In simulation, the material substrates of both components are Rogers RO4350B whose permittivity is $\xi_r = 3.48$. PIN diode bap5102, as an active device, is chosen. The equivalent parameters of PIN diodes are extracted through matching the transmission coefficients obtained from equivalent circuit and measurement.

The dimensions of the designed structure for simulations are listed in Table 1. In simulation, the boundaries of X and Y directions are set as unit cells, and that of Z direction is set open (add space). The PIN diodes are replaced by capacitance of 0.17 pf when they are in off-state and inductance of 0.4 nH in series of resistance of 10Ω when they are in on-state.

Table 1. Parameters list of designed structure for simulations.

parameters	H	l	s	a	b	w	w_1	w_2	d	d_1
Value(mm)	8.8	8.5	0.25	8	5	1	5.5	0.3	8.5	1

Figure 2 shows the simulated transmission coefficients with different numbers of basic unit cells in direction of z at two states. As shown in Fig. 2, the incident wave with low intensity can penetrate the structure with little loss (less than 1 dB) from 2 GHz to 3 GHz, and that with high intensity will be reflected. From Fig. 2, it can also be found that the structure with four basic unit cells has low insertion loss and high shielding effectiveness from 2 GHz to 3 GHz. Hence, this paper selects the structure with four basic unit cells to study the switchable property.

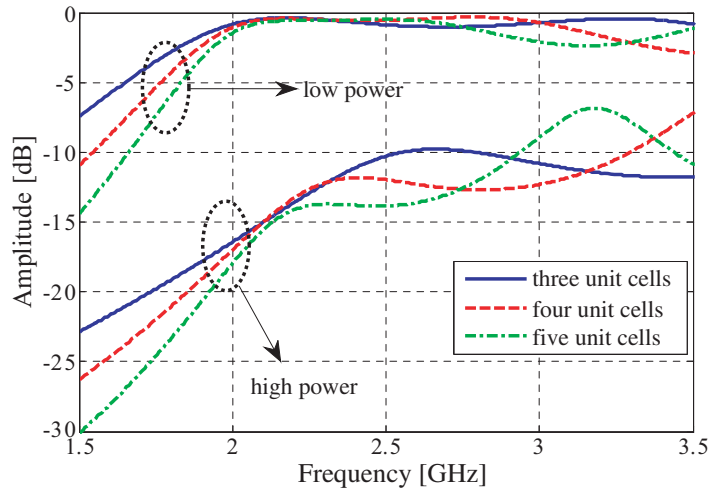

Figure 2. The transmission coefficients with different number of basic unit cells.

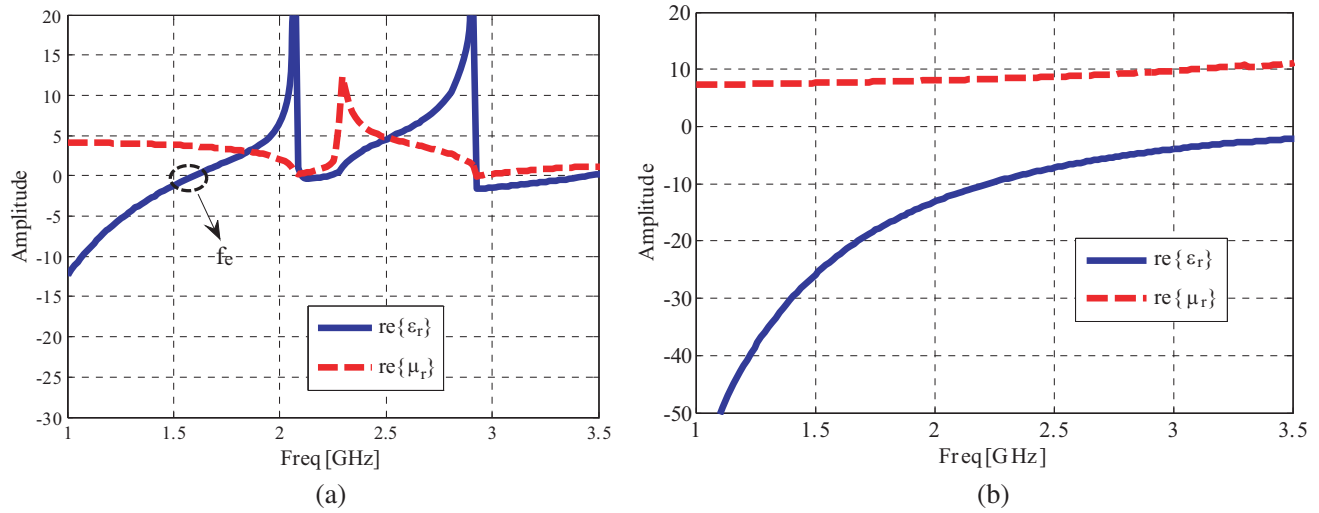

Figure 3. The effective material parameters in low and high power states extracted from the simulated S parameters with four cells. (a) Low power. (b) High power.

The equivalent permittivity and permeability of the structure with four unit cells are extracted based on the method in [12]. The real parts of equivalent permittivity and permeability are shown in Fig. 3. As shown in Fig. 3, the equivalent permittivity of structure on normal state is negative below the electric plasma frequency f_e , which is mainly decided by the inductive elements. When the intensity of incident wave is large enough to activate diode, the equivalent capacitance of structure decreases sharply, and the equivalent inductance increases slightly. The electric plasma frequency f_e is shifted to higher frequency. Hence, the band between the two electric plasma frequencies is switchable.

3. EXPERIMENT

In order to verify the switchable property of the designed structure, a prototype with four basic unit cells in the propagation of wave is fabricated, shown in Fig. 4. The signal generator Agilent 8267D and amplifier are adopted to produce the local strong field in waveguide to activate the diode. There are six boards in vertical direction and twelve boards in horizontal direction in the waveguide’s cross section.

The measurement setup is shown in Fig. 5. The signal generator Agilent 8267D is employed to

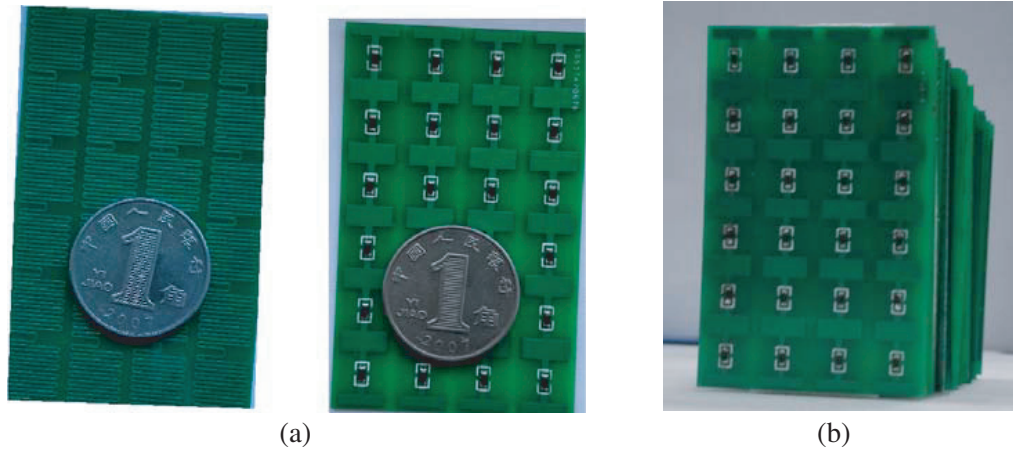

Figure 4. The prototype of structure. (a) Unit cell of 3D structure. (b) 3D structure.

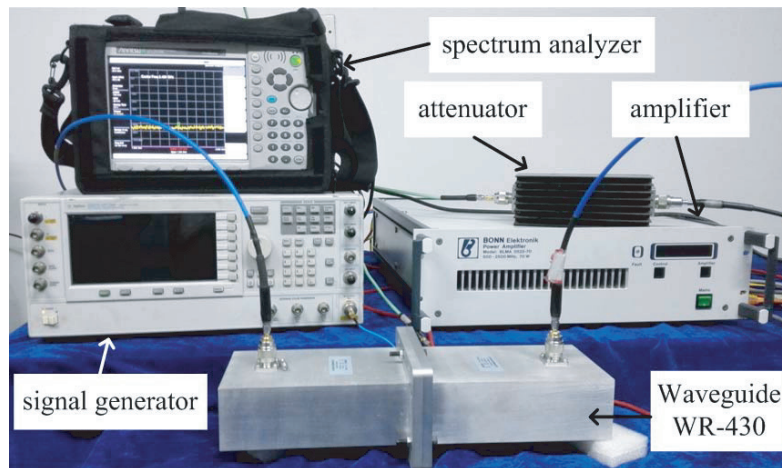
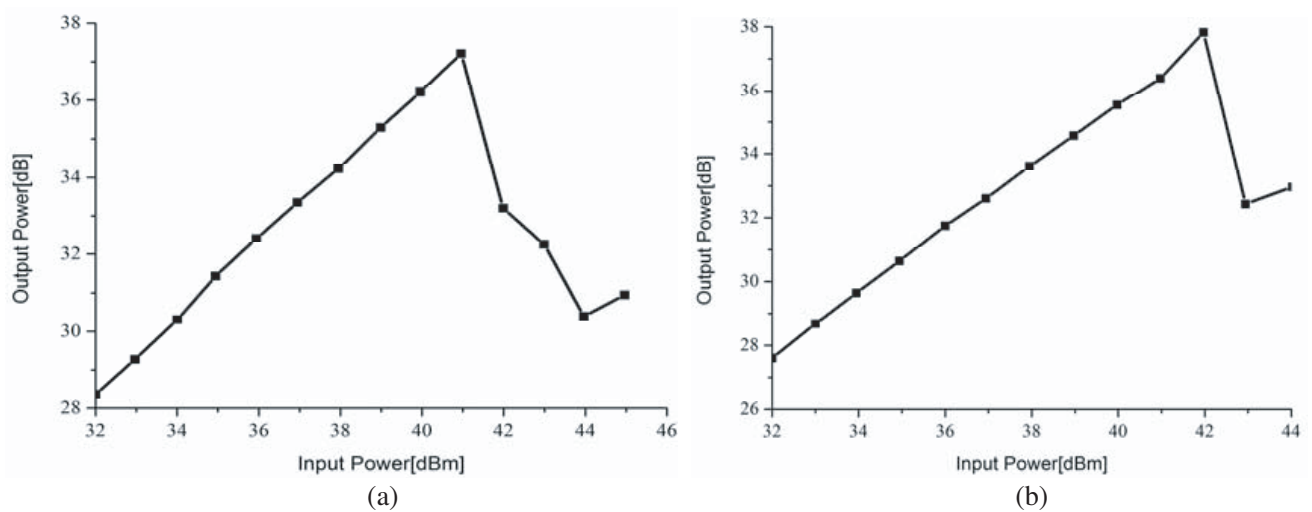

Figure 5. The measurement setup for switchable property of structure.



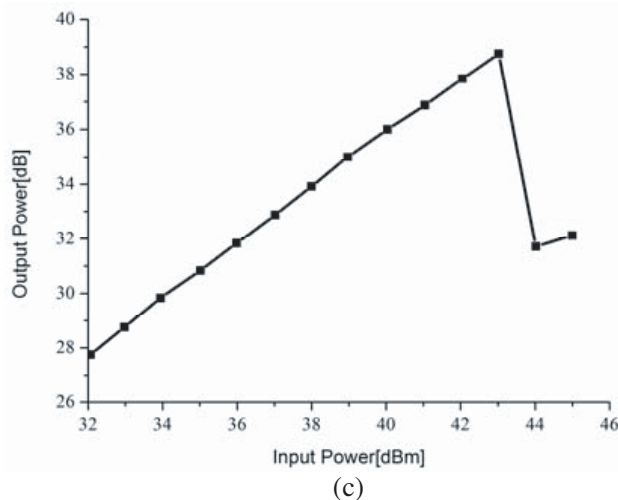

Figure 6. The relationship between input power and output power at different frequencies. (a) 1.8 GHz. (b) 2.1 GHz. (c) 2.5 GHz.

produce the needed signal. The amplifier Bonn Elektronik BLMA 0525-70 is adopted. Its operating frequency ranges from 0.5 GHz to 2.5 GHz. The maximum output power is 70 W when the incident power reaches 0 dBm. The spectrum analyzer Anritsu MS2038C is used as the receiver, and the amplitude of attenuator is 30 dB.

The switchable property of 3D structure is verified at three different frequencies, which are 1.8 GHz, 2.1 GHz and 2.5 GHz. The relationships between incident power and output power at above frequencies are shown in Fig. 6.

As shown in Fig. 6, the output power increases linearly with the input power when the intensity of input power is low. As the input power goes on increasing to make the diode conduct, the intensity of output power will decrease drastically. The above results illustrate the switchable characteristic of the designed structure.

4. CONCLUSIONS

In this article, a 3D structure with broadband switchable and low insertion passband is designed and fabricated. The effective material parameters in low and high power states are adopted to illustrate the working principle of the structure. Compared to other methods, the proposed one has wider working band, in which working signal can pass through it with little loss, and the wave with high intensity can be reflected. The simulated results show that the passband ranges from 2 GHz to 3 GHz, in which the insertion loss is less than 1 dB. When diode turns on, the shielding effectiveness reaches 10 dB. A prototype of the 3D structure is fabricated. The measurement results at different frequencies show that the designed structure owns broadband switchable property.

REFERENCES

1. Nitsch, D., M. Camp, F. Sabath, et al., "Susceptibility of some electronic equipment to HPEM threats," *IEEE Transactions on Electromagnetic Compatibility*, Vol. 46, No. 3, 380–389, 2004.
2. Monni, S., D. Bekers, M. van Wanum, et al., "Limiting frequency selective surface," *EuMC 2009 Microwave Conference*, 606–609, Rome, European, 2009.
3. Yang, C., P. Liu, and X. Huang, "A novel method of energy selective surface for adaptive HPM/EMP protection," *IEEE Antennas and Wireless Propagation Letters*, Vol. 12, No. 2013, 112–115, 2013.

4. Katko, A. R., A. M. Hawkes, J. P. Barrett, and S. A. Cummer, "RF limiter metamaterial using p-i-n diodes," *IEEE Antennas and Wireless Propagation Letters*, Vol. 10, 1571–1574, 2011.
5. Kim, S., H. Wakasuchi, J. J. Rushton, and D. F. Sievenpiper, "Switchable nonlinear metasurfaces for absorbing high power surface waves," *Applied Physics Letters*, Vol. 108, 041903, 2016.
6. Wakasuchi, H., J. J. Rushton, J. Lee, F. Gao, et al., "Experimental demonstration of nonlinear waveform-dependent metasurface absorber with pulsed signals," *Electronics Letters*, Vol. 49, No. 24, 1530–1531, 2013.
7. Wakasuchi, H., S. Kim, J. J. Rushton, and D. F. Sievenpiper, "Circuit-based nonlinear metasurface absorbers for high power surface currents," *Applied Physics Letters*, Vol. 102, 214103, 2013.
8. Wakasuchi, H., S. Kim, J. J. Rushton, and D. F. Sievenpiper, "Waveform-dependent absorbing metasurfaces," *Physics Review Letters*, Vol. 111, No. 24, 245501, 2013.
9. Wakasuchi, H., J. J. Rushton, S. Kim, and D. F. Sievenpiper, "Metasurfaces to select waveforms at the same frequency," *8th International Congress on Advanced Electromagnetic Materials in Microwaves and Optics — Metamaterials*, 2014.
10. Wall, W. S., S. M. Rudolph, S. K. Hong, and K. L. Morgan, "Broadband switching nonlinear metamaterial," *IEEE Antennas and Wireless Propagation Letters*, Vol. 12, 427–430, 2014.
11. Scott, S., C. D. Nordquist, et al., "A frequency selective surface with integrated limiter for receiver protection," *IEEE Antennas and Propagation Society International Symposium (APSURSI)*, 1–2, 2012.
12. Szabo, Z., G.-H. Park, R. Hedge, and E.-P. Li, "A unique extraction of metamaterial parameters based on Kramers-Kronig relationship," *IEEE Transactions on Microwave Theory and Technology*, Vol. 58, No. 10, 2646–2653, 2010.